

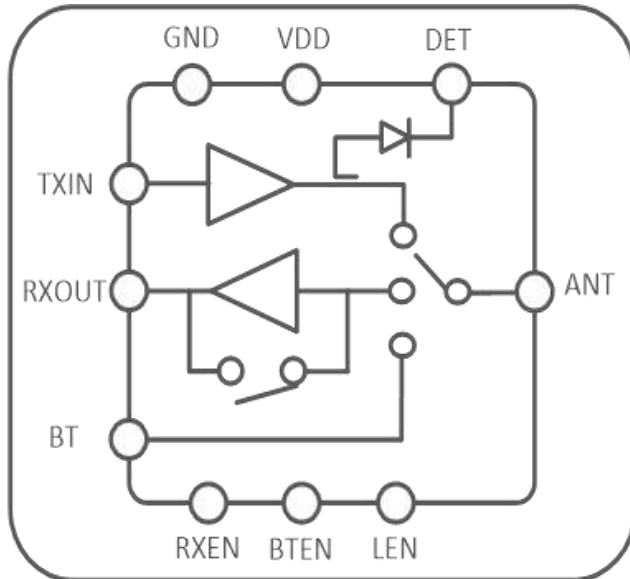

RFX8422S CMOS Single-Chip/Single-Die 2.4GHz RFeIC with PA, LNA & SP3T for Dual-Mode WiFi/Bluetooth Operation in Mobile Devices

Evaluation Board Test Results Summary & Technical Notes

Functional Block Diagram



Product Overview

- Pure CMOS Single-Chip, Single-Die RF Front-End IC
- PA + LNA + SP3T Switch + Harmonic Filters
- High Linearity PA 802.11n/ac WLAN & BT
- Low Noise Figure WLAN Receive LNA with Bypass for Near Range Operation
- 2.4 – 2.5 GHz Frequency Band
- Direct Battery Operation
- Complete On-Chip RF Decoupling and DC Block Capacitors – No External Inductors
- 2.5mm x 2.5mm x 0.45 mm, 16L QFN Package

RFX8422S Applications

- Smartphones, Feature Phones and MIDs with WLAN/Bluetooth
- WLAN/Bluetooth Platforms Requiring Shared Antenna
- Laptop / Netbook / Smartbook with Embedded WiFi & Bluetooth
- Portable Platforms with Integrated 802.11n/ac and Bluetooth

RFX8422S Pin-out and Pin Description

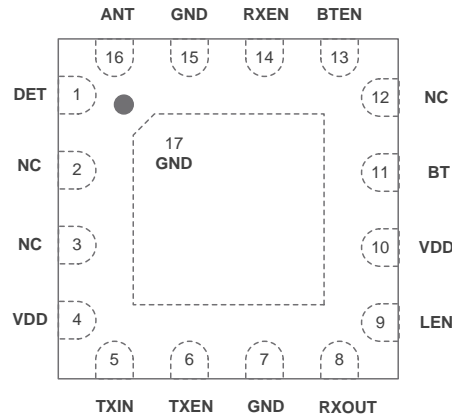

(Top "See-Through" View)

Pin Number	Pin Name	Description
1	DET	PA Power Detector Output
2, 3, 12	NC	Not Connected Internally. Can be Grounded or Left Open
4, 10	VDD	DC Voltage Supply
5	TXIN	WLAN TX Signal Port from the Transceiver: DC Shorted to GND
6	TXEN	CMOS Logic Control to Enable WLAN Transmit
7, 15, Paddle	GND	Ground – Must be Connected to Ground
8	RXOUT	WLAN RX Signal Port to the Transceiver: DC Shorted to GND
9	LEN	CMOS Logic Control to Enable LNA. Use to switch between the LNA and Bypass modes
11	BT	RF signal Port from/to the Bluetooth Transceiver: DC Shorted to GND
13	BTEN	CMOS Logic Control to Enable Bluetooth
14	RXEN	CMOS Logic Control to Enable WLAN Receive
16	ANT	RF Signal Port to/from the Antenna: DC Shorted to GND

Recommended BOM

Designator	Value	Footprint	Notes
C1	2.2uF	0402	X5R/X7R
C2	220pF	0402	X5R/X7R
C3	1uF	0402	X5R/X7R
C4	0.3pF	0402	COG
R1	10KΩ	0402	Det. Load
R2, R3, R4, R5	1KΩ	0402	*

* Only need if the control pin is directly connected to VDD.

Control Logic Truth Table

TXEN	BTEN	RXEN	LEN	Mode of Operating
0	0	0	0	Shutdown Mode
1	0	0	0	WLAN Transmit Mode
0	0	1	1	WLAN Receive. High Gain Mode
0	0	1	0	WLAN Receive. Bypass Mode
0	1	0	0	Bluetooth Transmit/Receive Mode

Note: "1" denotes high voltage state (> 1.2V) at Control Pins
 "0" denotes low voltage state (< 0.3V) at Control Pins

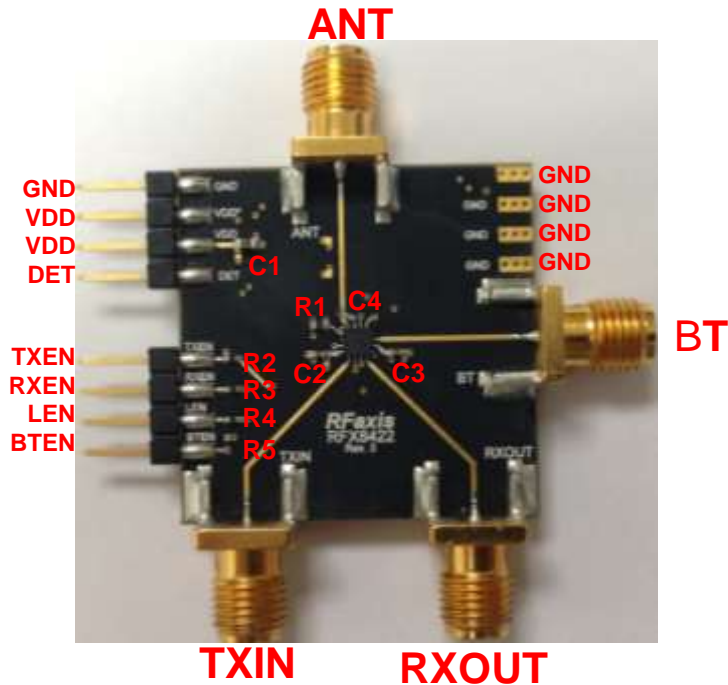

Evaluation Board Information:

- 4-Layer Stack, 10mil/40mil/10mil
- FR4 with $\epsilon_r=4.5$, $\tan \delta = 0.02$ (Typ)
- RFIN, RFOUT trace losses are $\sim 0.25\text{dB}$ @ 2.4GHz – 2.5GHz
- Results in following slides are referenced to device pins with the trace loss de-embedded
- VDD should be on before applying ctrl signals
- VDD Nominal 3.6 Vdc. Operational from 2.9 to 4.5 Vdc with limitations.

Recommended Application Schematic and BOM

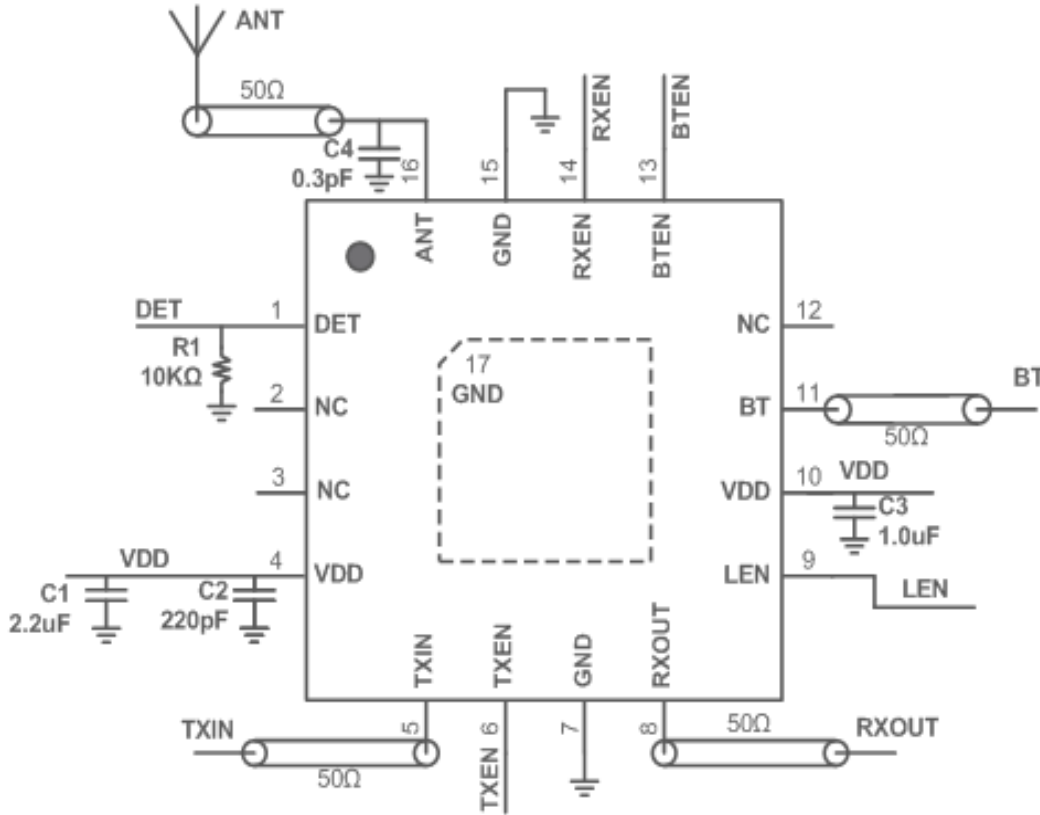

Designator	Value	Footprint	Notes
C1	2.2uF	0402	X5R/X7R
C2	220pF	0402	X5R/X7R
C3	1uF	0402	X5R/X7R
C4	0.3pF	0402	COG
R1	10KΩ	0402	*

* Detector Voltage will vary with different resistor loads.

Nominal VDD = 3.6 Vdc
 Operation from 2.9 to 4.5 Vdc with limitations

EVB Signal Loss De-Embedding

RF Signal	Loss
ANT	.20 dB
TX	.20 dB
RX	.25 dB
BT	.25 dB

Total EVB Loss Includes the Trace and Connector

RFX8422S DEVM vs. Output Power over Frequency 802.11g 64 QAM

DEVM [dB] VDD = 3.6V

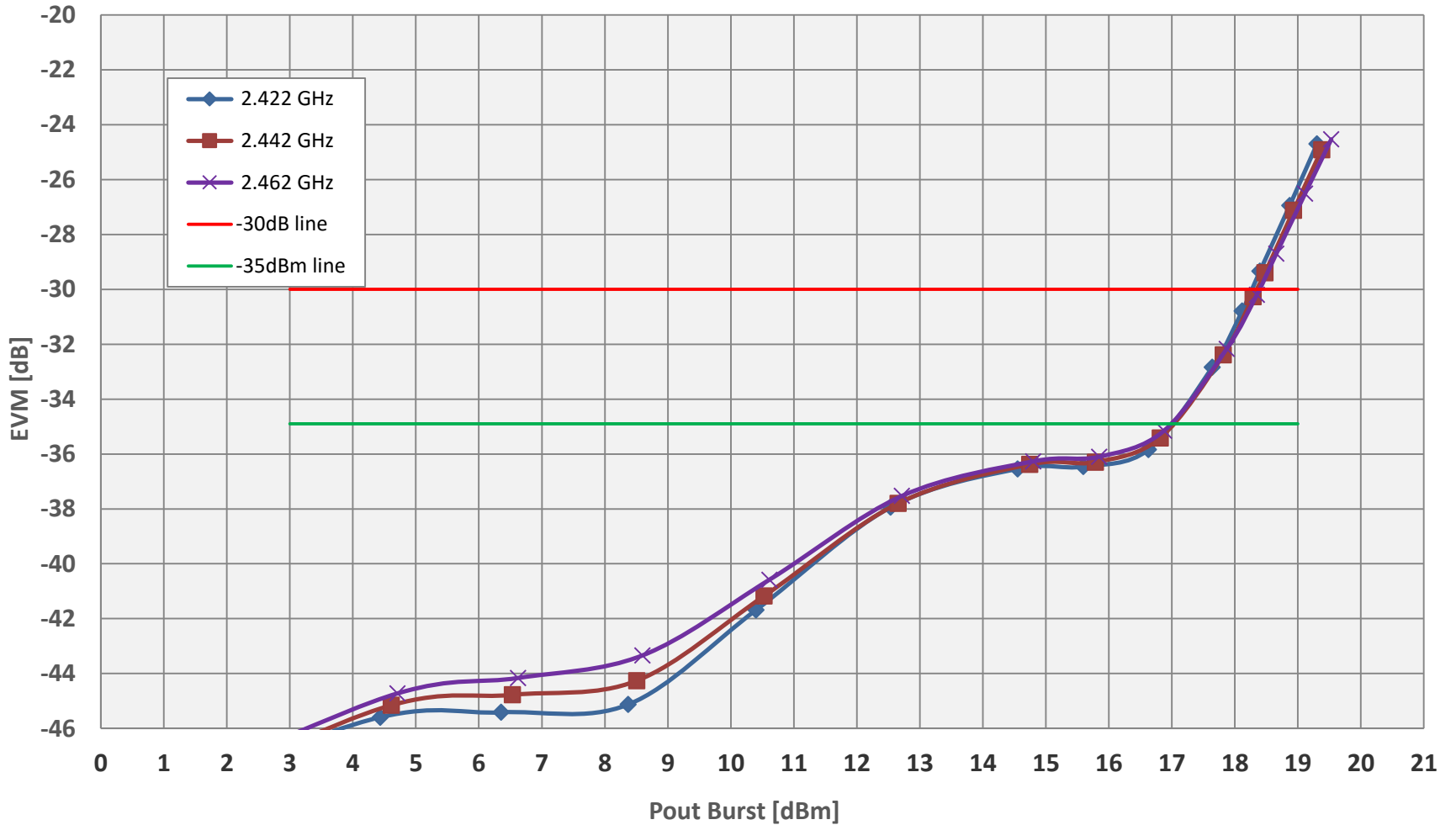

RFX8422S DEVM vs. Output Power over Frequency 802.11n HT20 MCS7

DEVM [dB] VDD = 3.6V

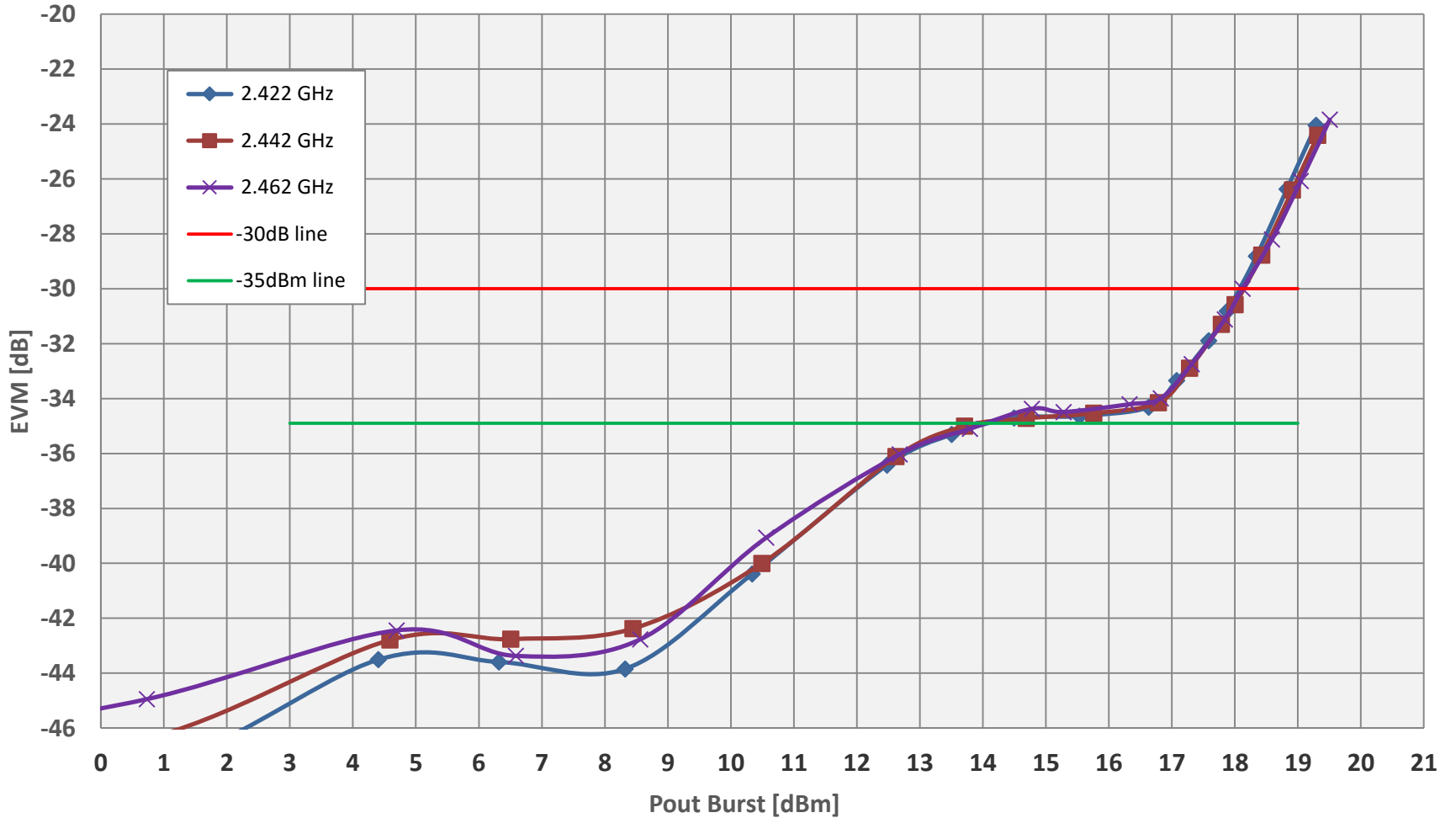

RFX8422S DEVM vs. Output Power over Frequency

802.11n HT40 MCS7

DEVM [dB] VDD = 3.6V

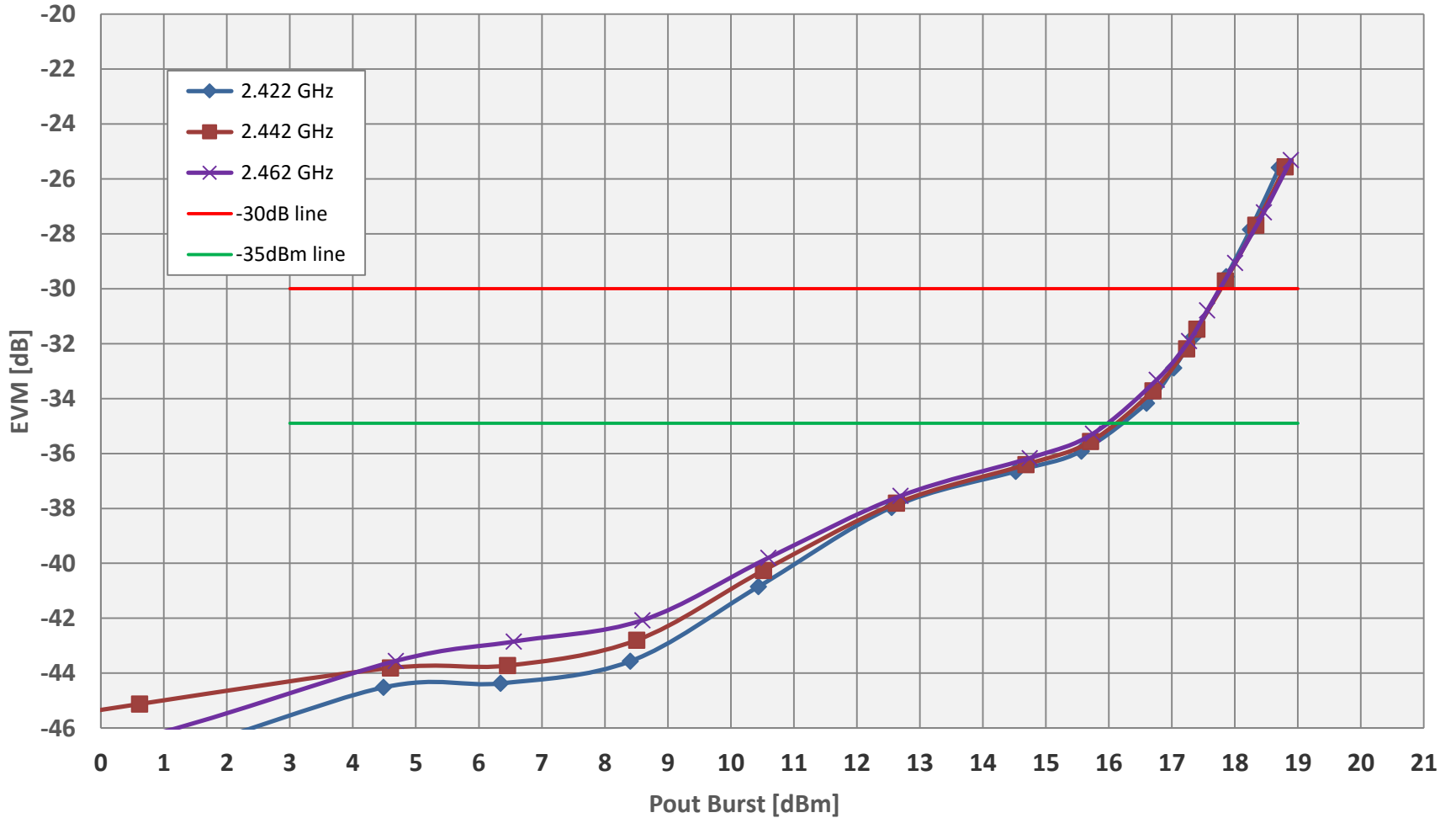

RFX8422S DEVM vs. Output Power over Frequency

802.11ac VHT40 MCS9

DEVM [dB] VDD = 3.6V

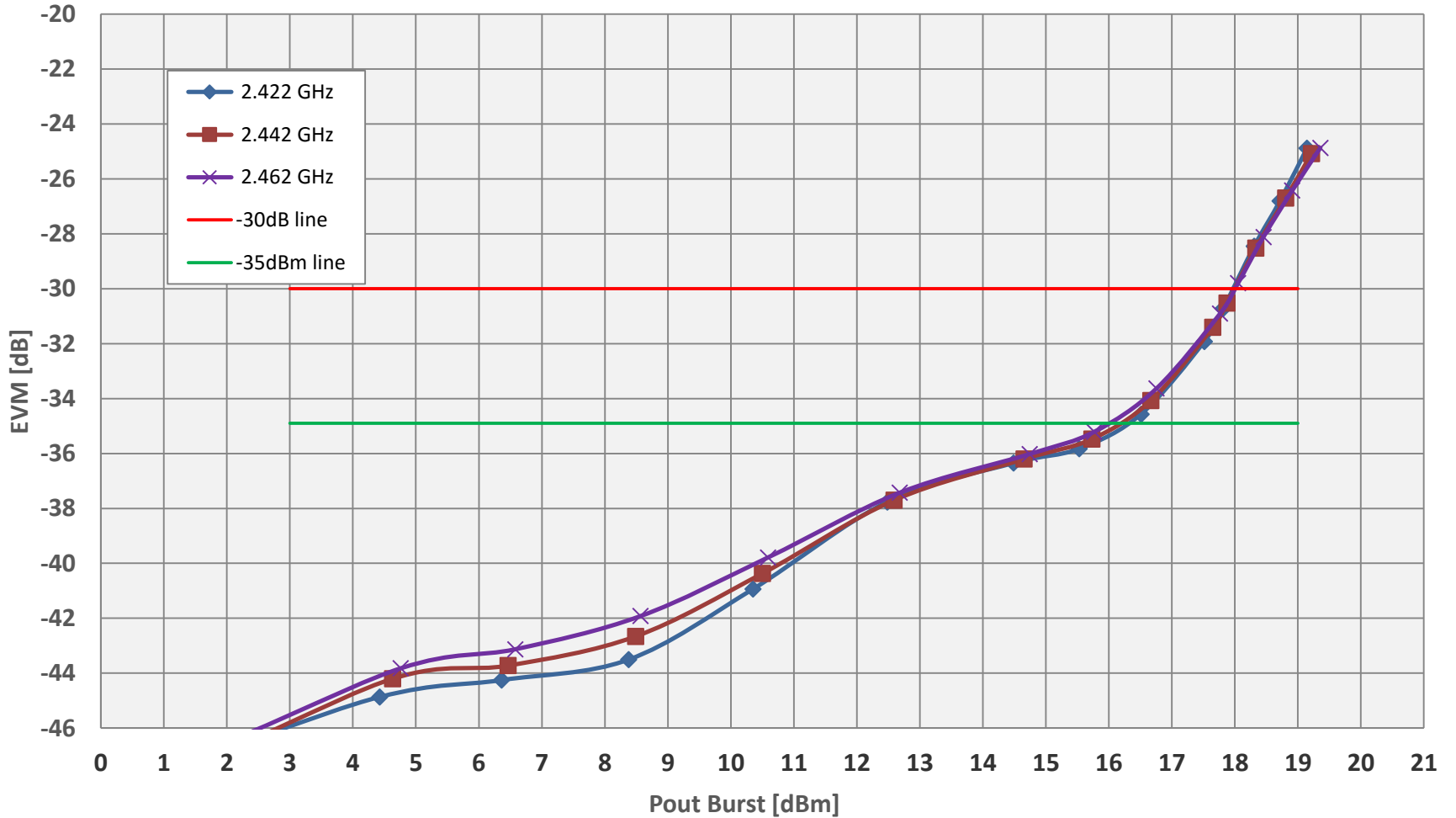

RFX8422S Gain and Current over Frequency

VDD = 3.6V

Gain VDD = 3.6

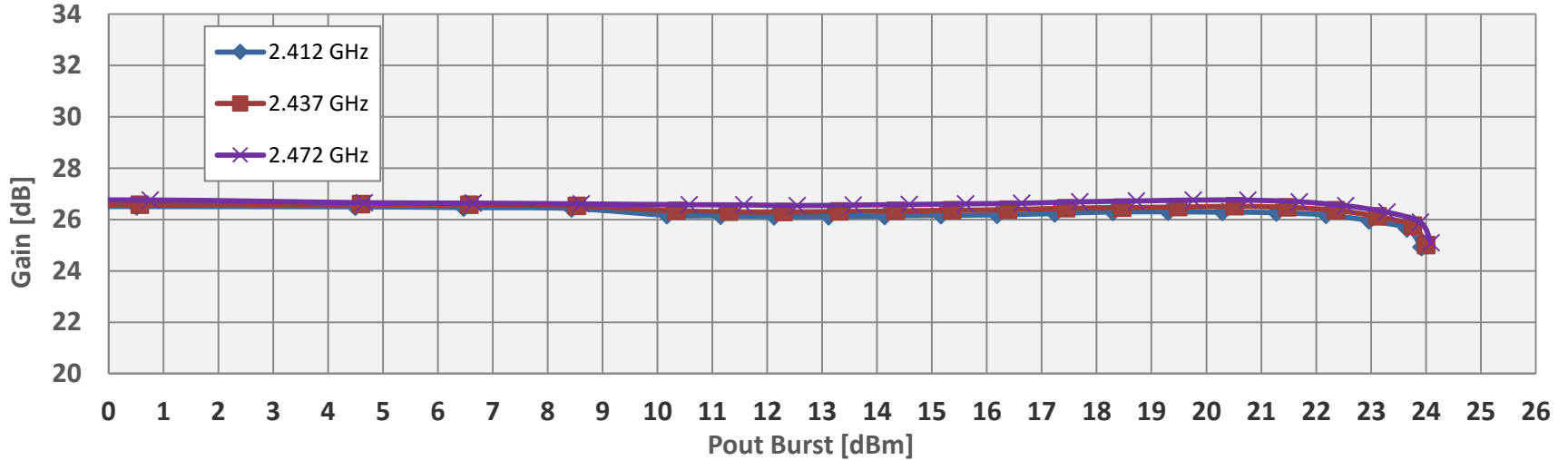

Max Current VDD = 3.6

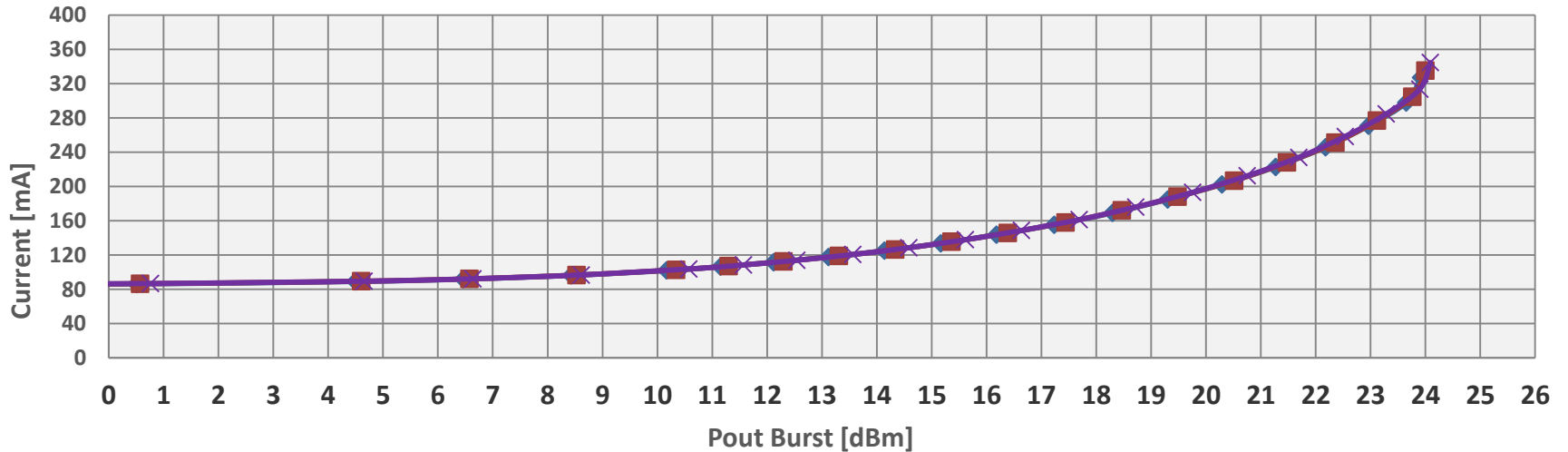

2nd Harmonic

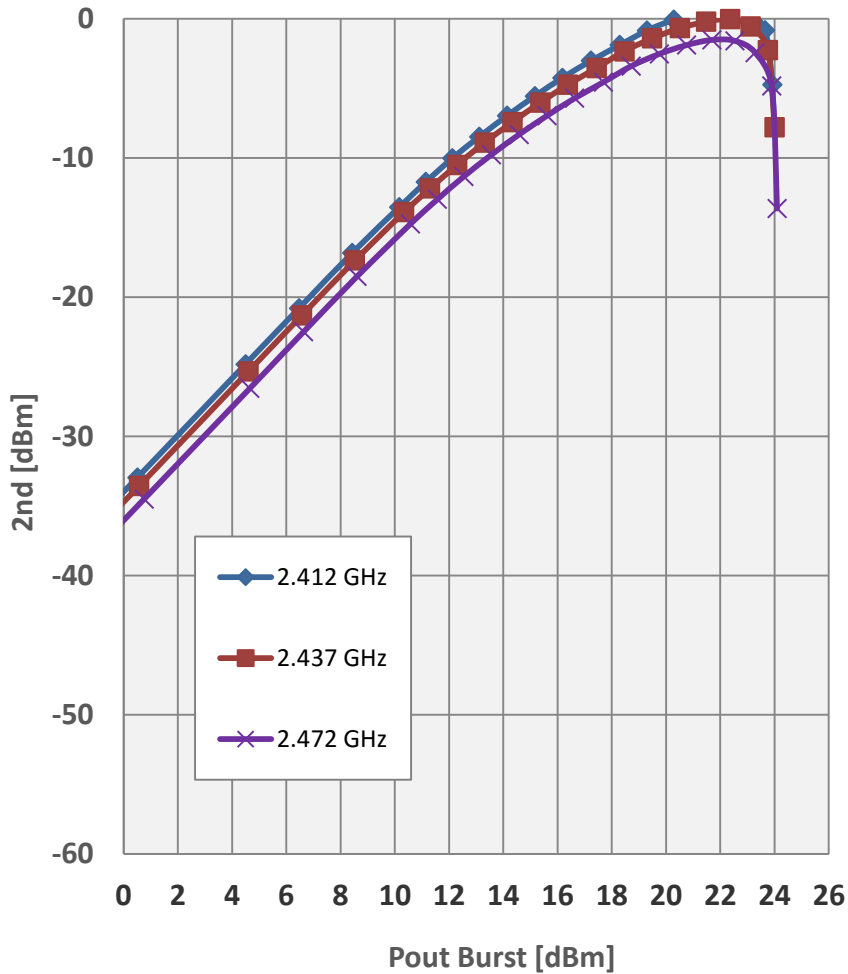

3rd Harmonic

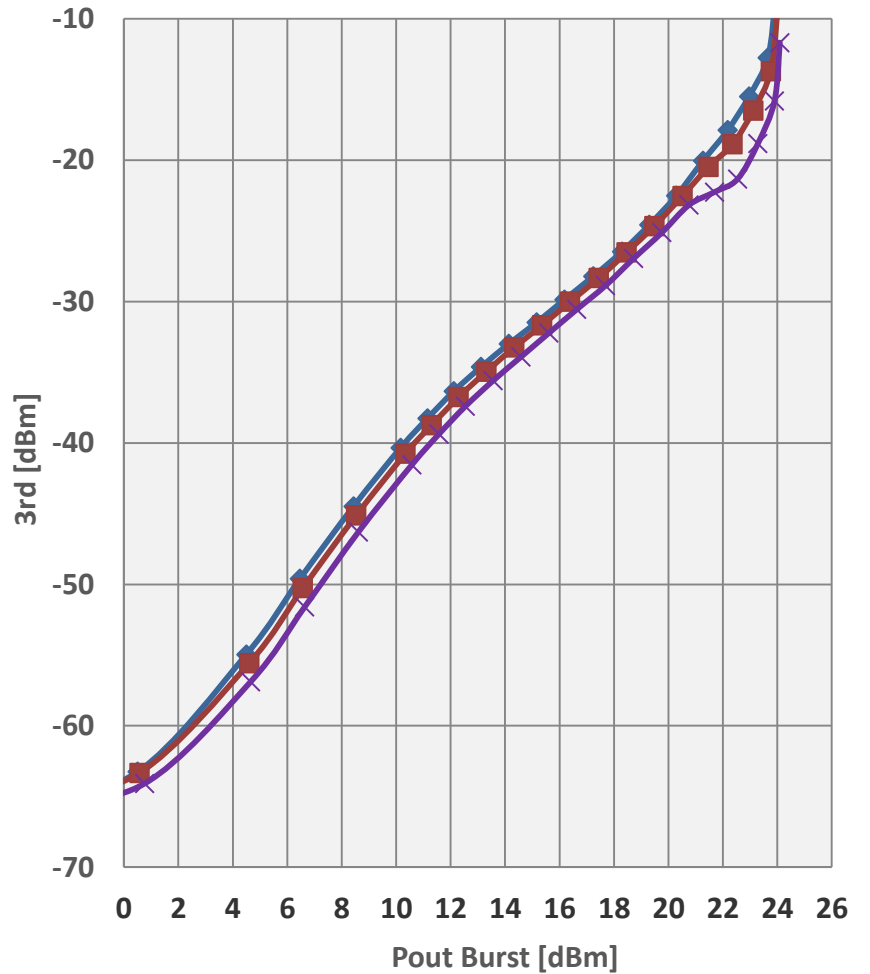

RFX8422S Detector Output Voltage vs. Pout, over Frequency CW Signal

Vdet VDD = 3.6

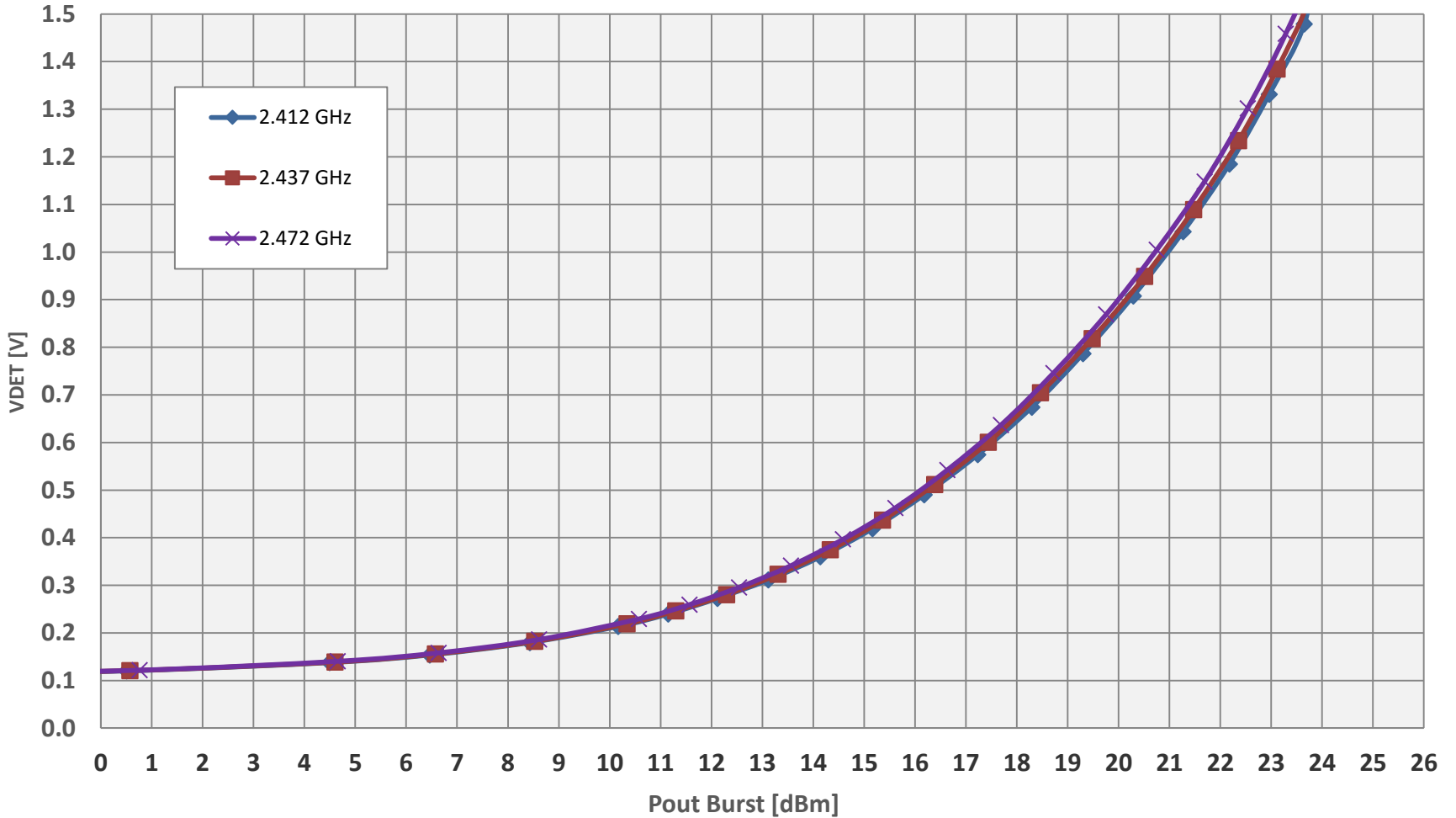

Detector voltage measured with 10kΩ load. Detector voltage will be vary with different resistor load values.

RFX8422S LNA Gain and Noise Figure vs. Frequency

VDD = 3.6V

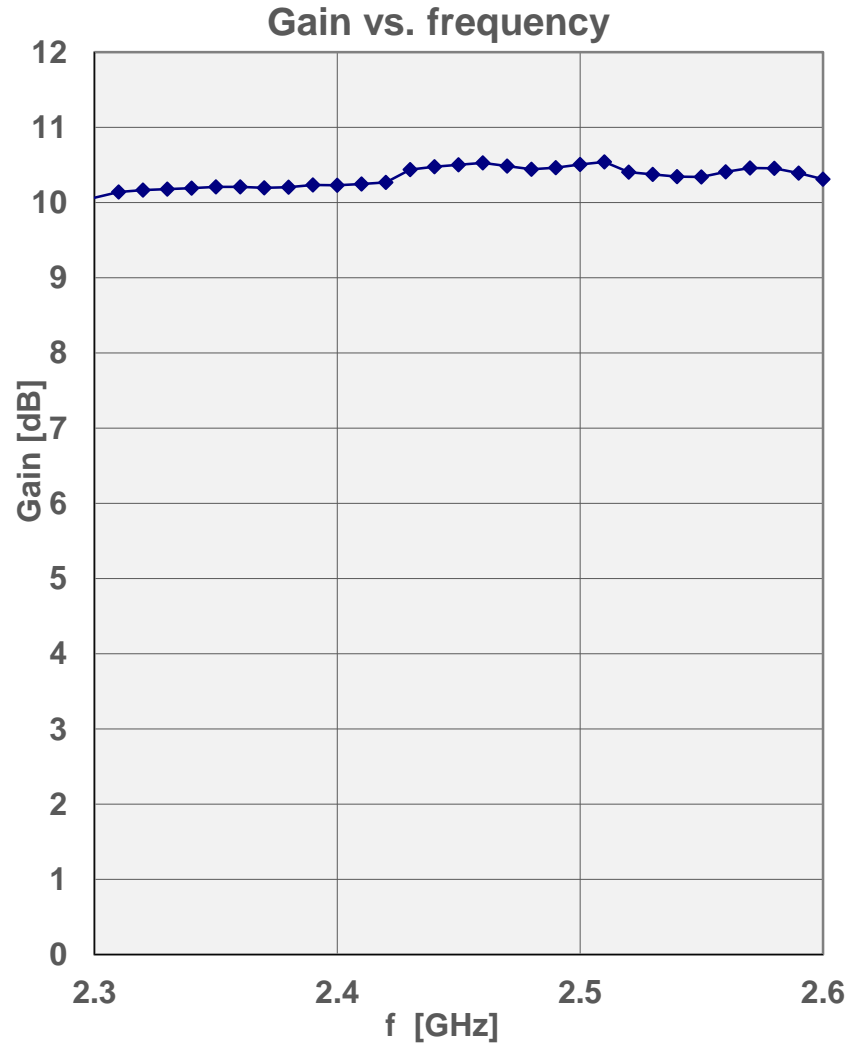
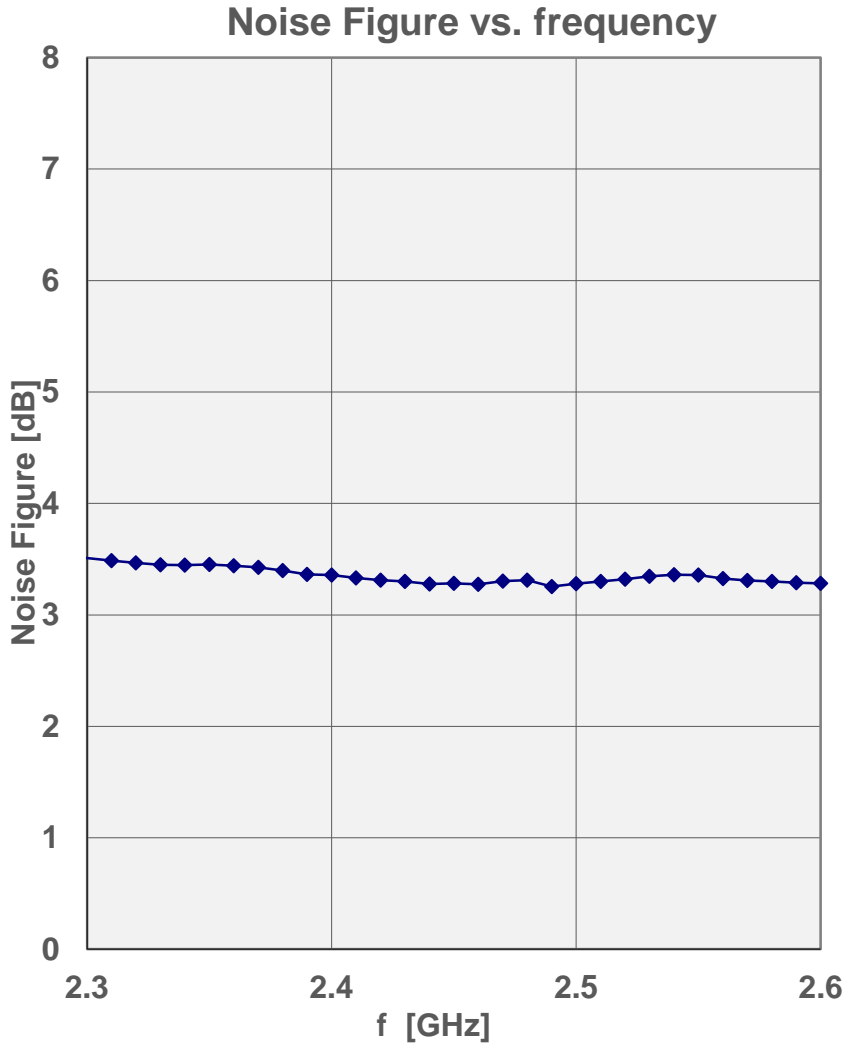

RXEN=High, LEN=High, TXEN=BTEN=Low, Iq= 12 mA

RFX8422S TX Small-Signal S21, S11

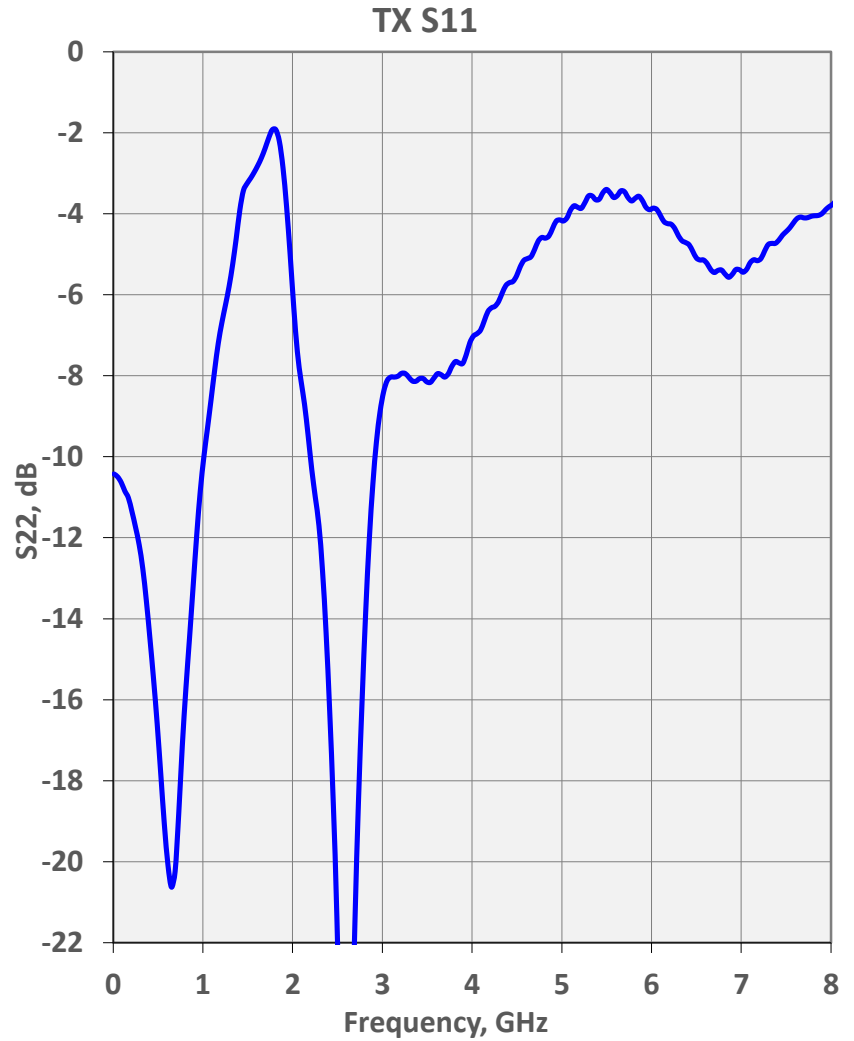
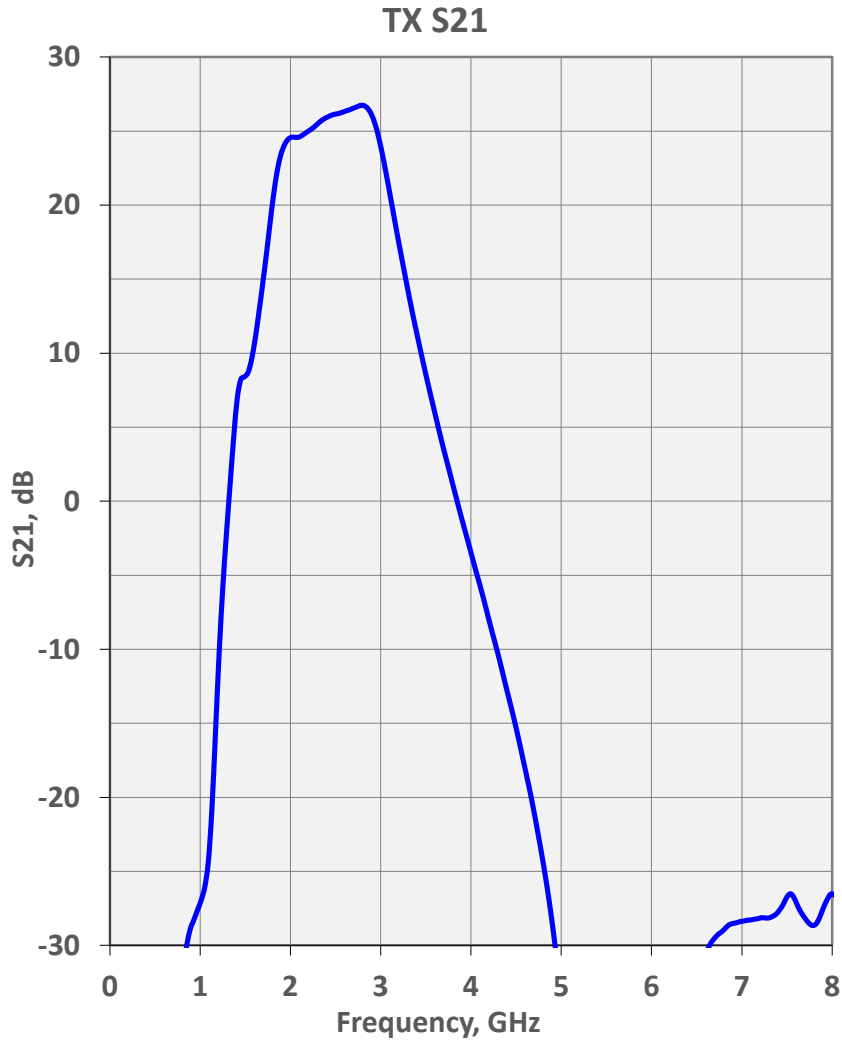

TXEN=High, RXEN=BTEN=Low, Icq~90mA @ VDD=3.6V

RX S21

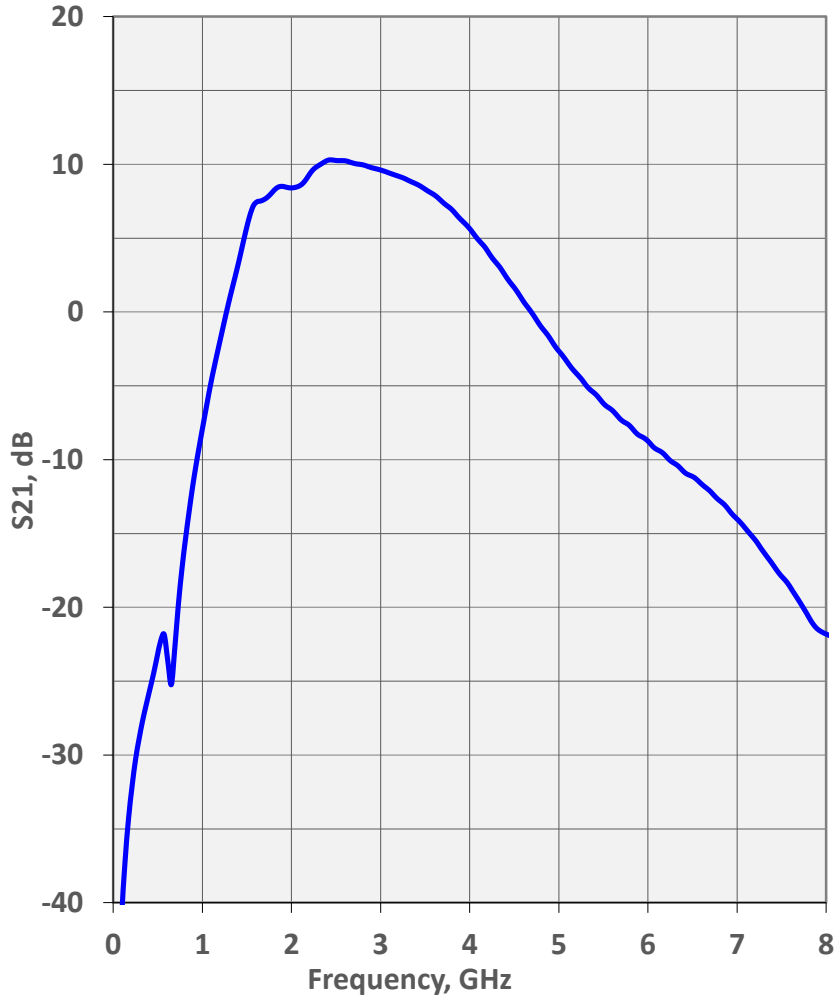

RX S22

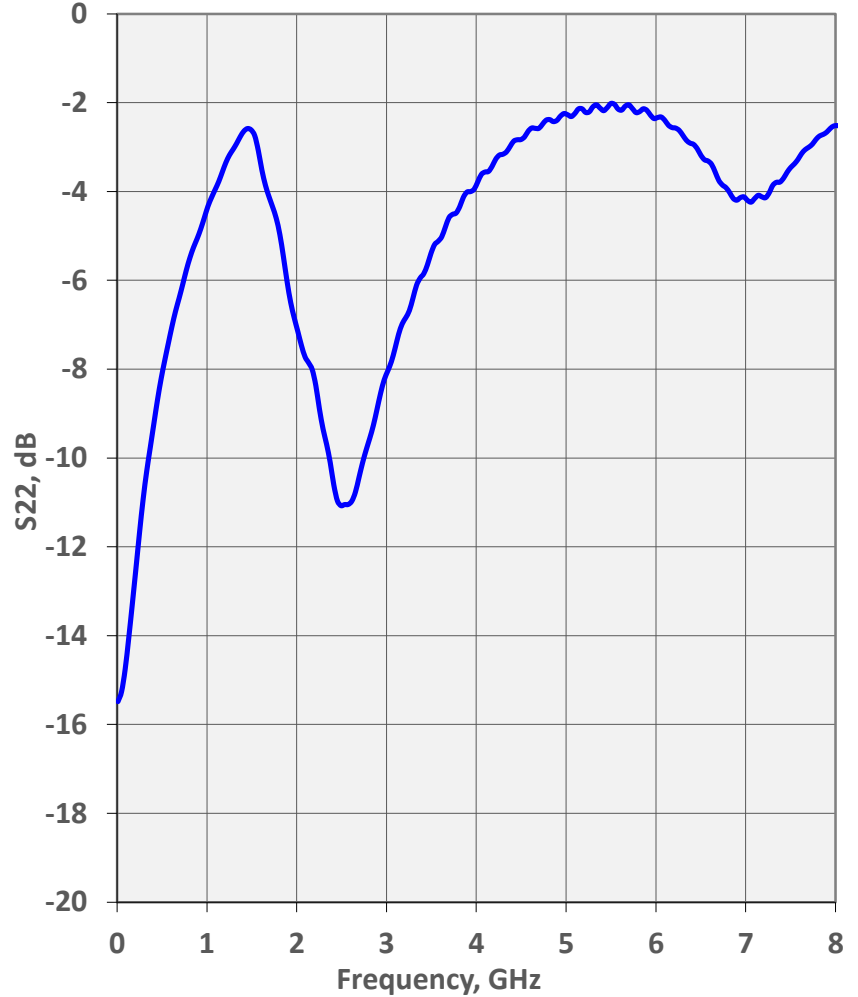

RXEN LEN=High, TXEN=BTEN=Low, LNA Iq= 12 mA

RX Bypass S21

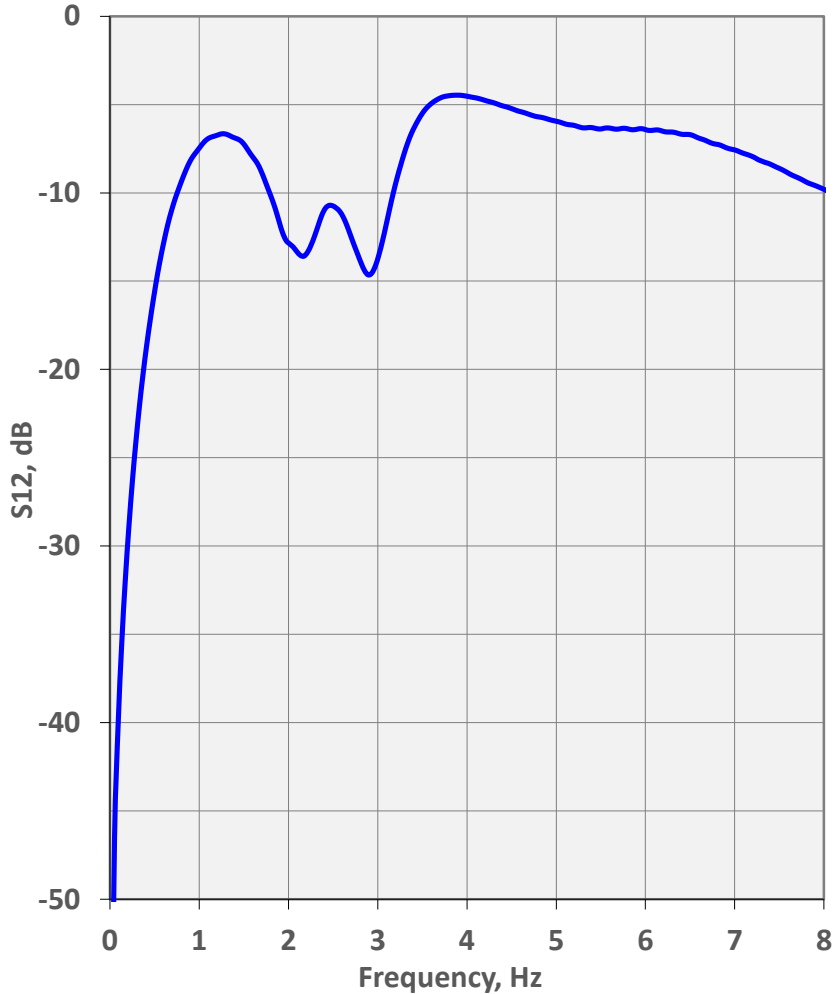

TXEN LEN BTEN=Low, RXEN=High, Iq= 1 mA

BT S21

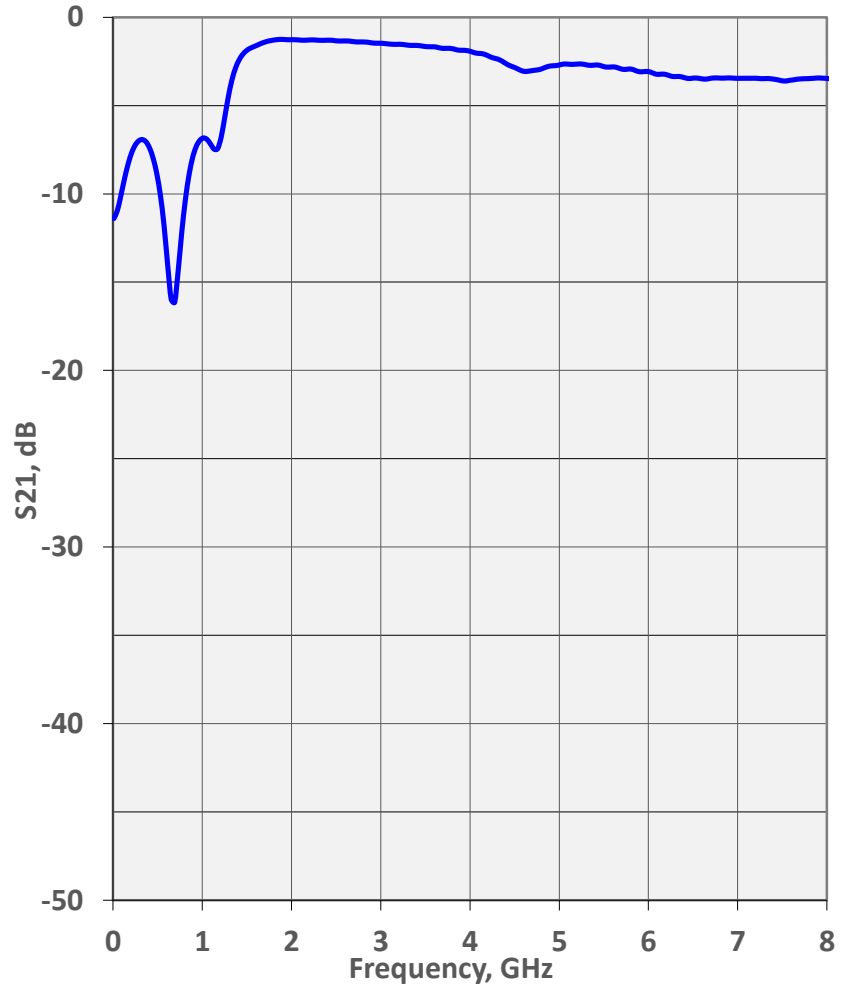

TXEN RXEN LEN=Low, BTEN=High, Iq= 1 mA

RFX8422S
VDD = 3.3V
Supplemental Data

RFX8422S DEVM vs. Output Power over Frequency 802.11n HT40 MCS7

DEVM [dB] VDD = 3.3V

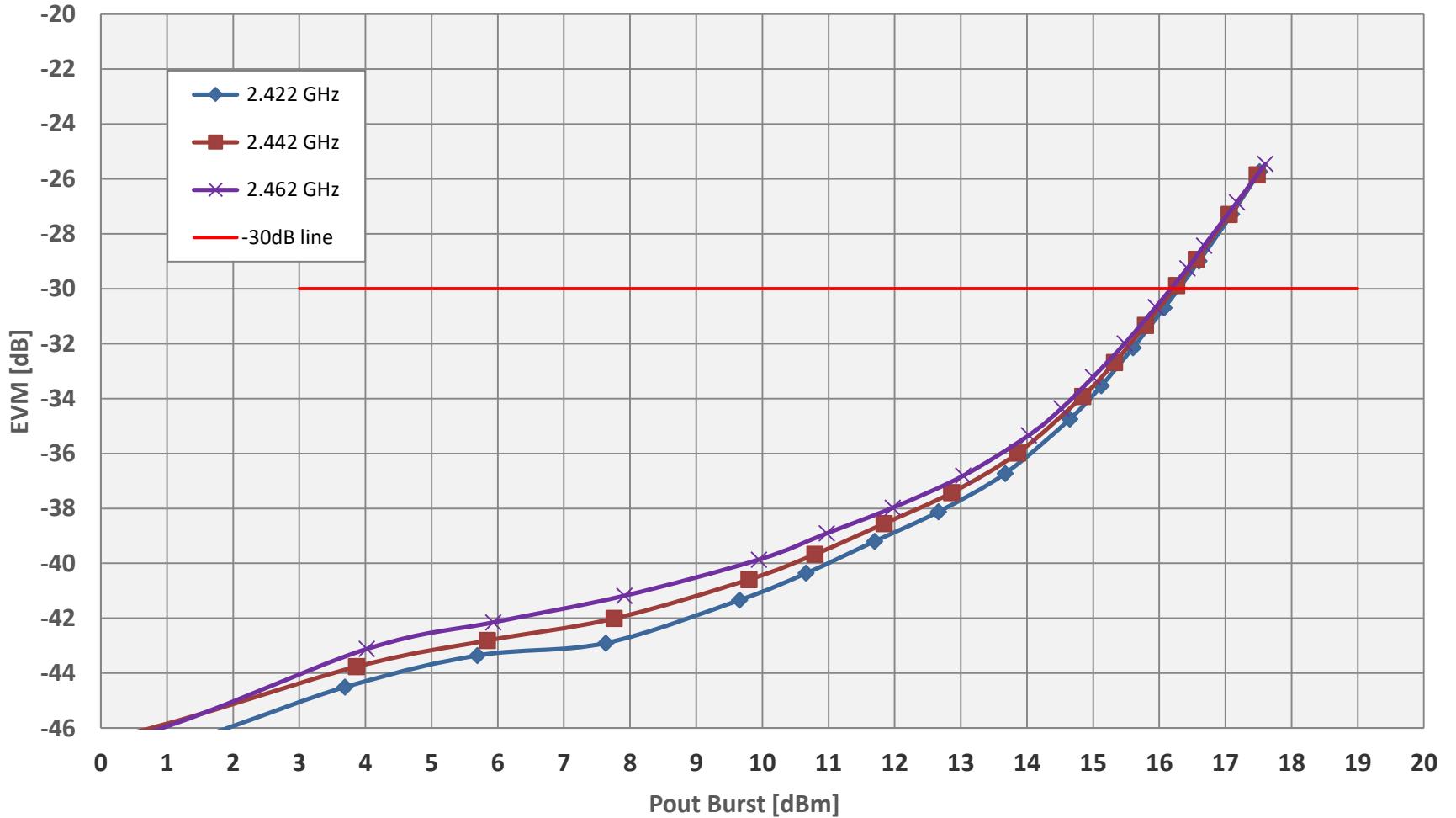

RFX8422S DEVM vs. Output Power over Frequency

802.11n HT20 MCS7

DEVM [dB] VDD = 3.3V

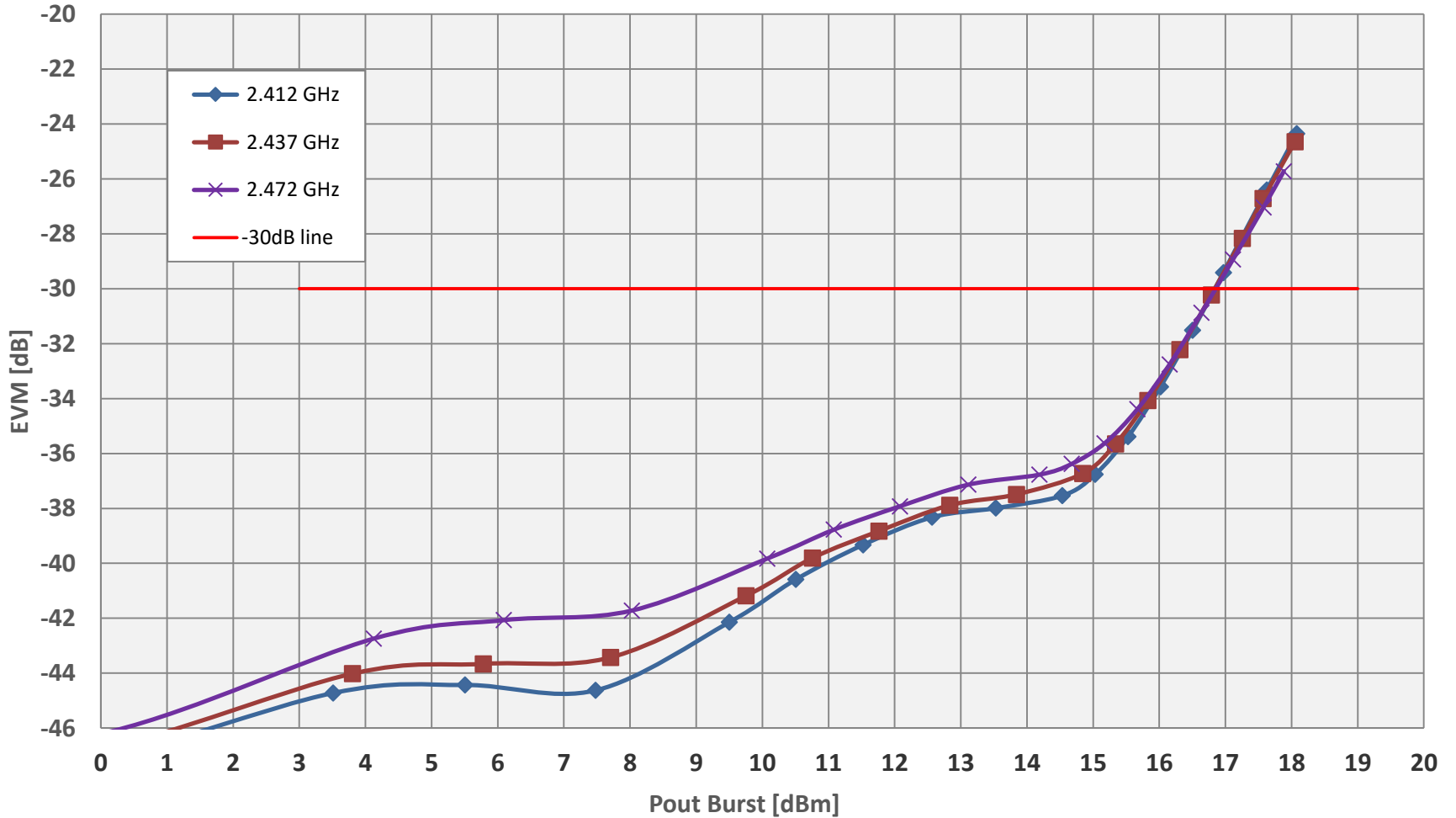

RFX8422S DEVM vs. Output Power over Frequency

802.11ac HT40 MCS9

DEVM [dB] VDD = 3.3V

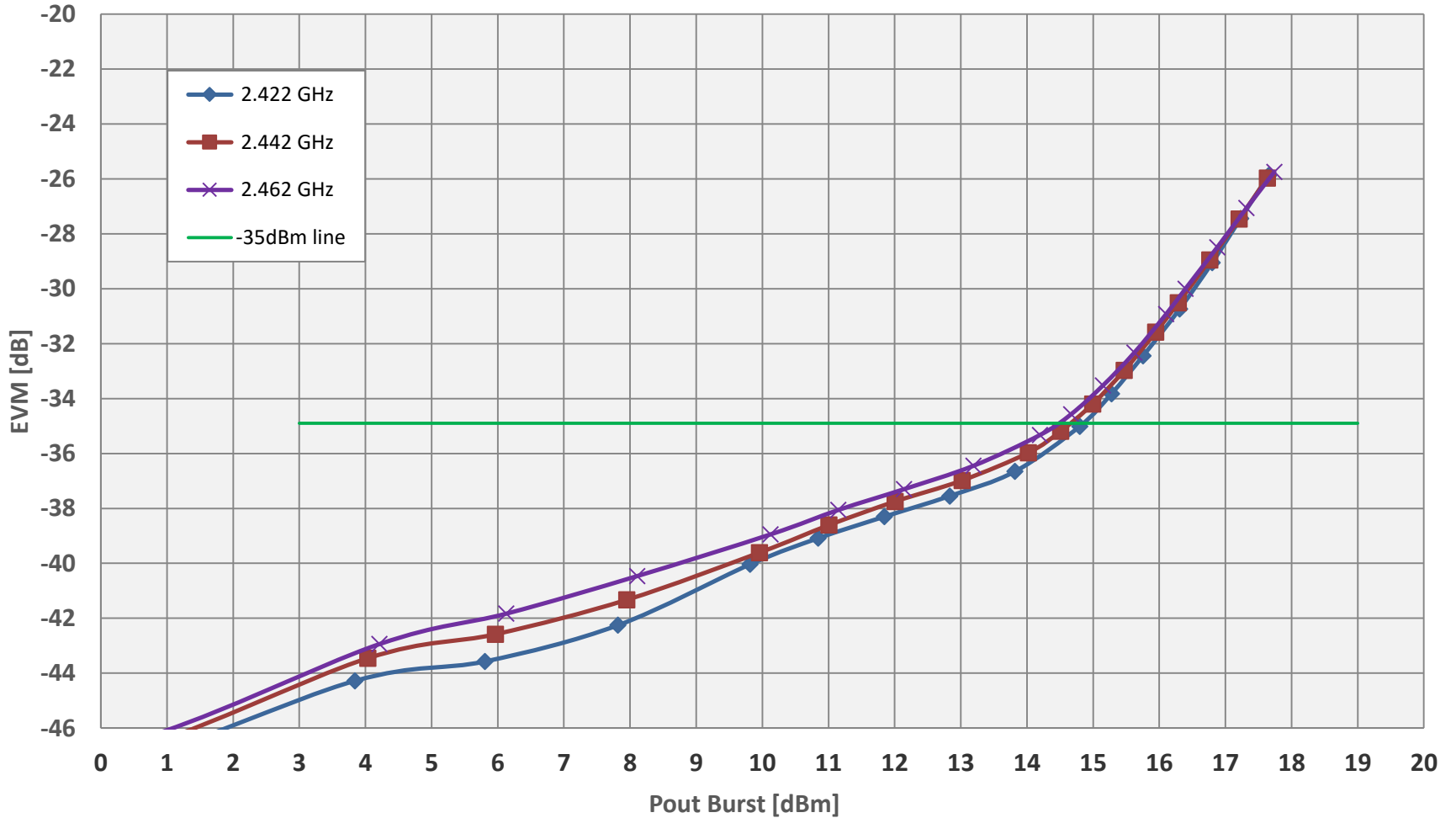

RFX8422S CW Gain and Current over Frequency

VDD = 3.3V

Gain VDD = 3.3V

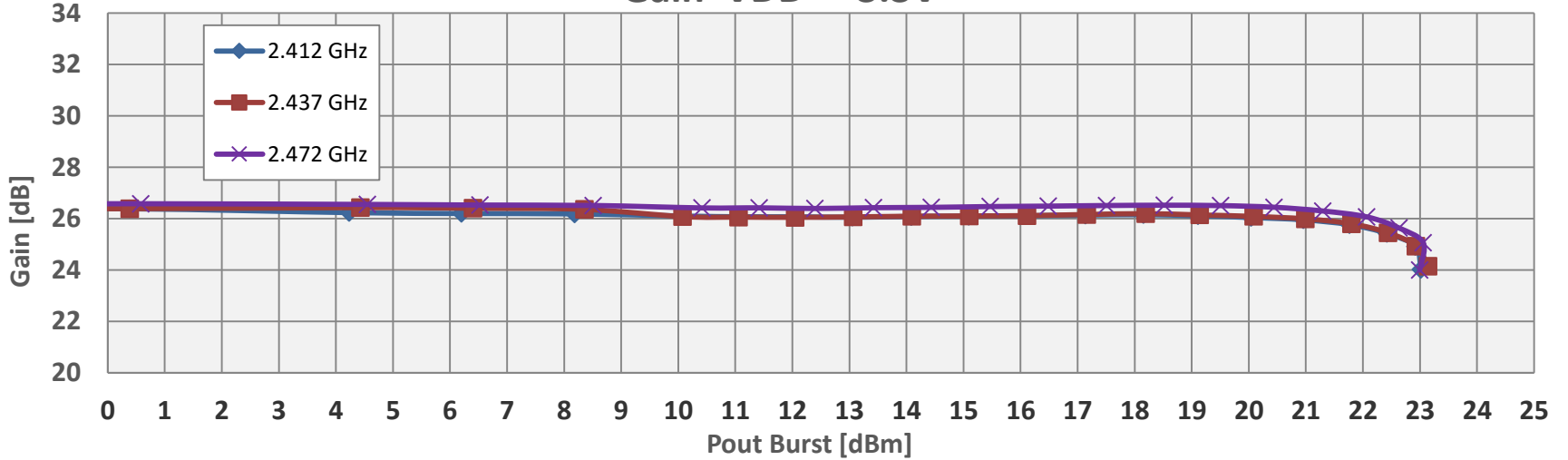

Max Current VDD = 3.6V

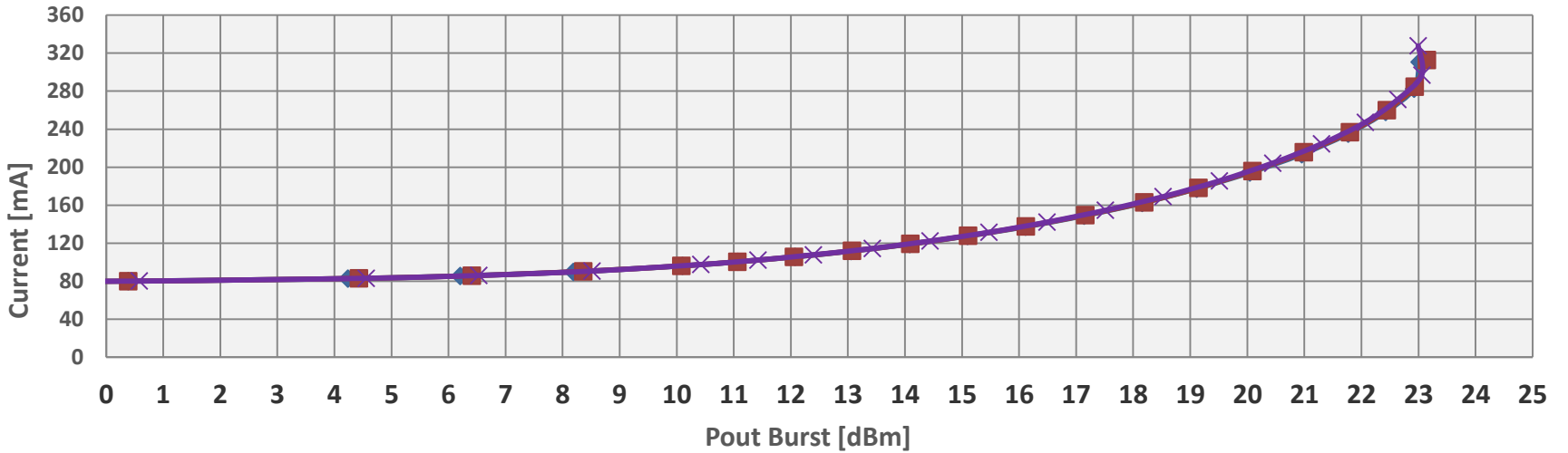

RFX8422S CW Harmonics over Frequency

VDD = 3.3V

2nd Harmonic

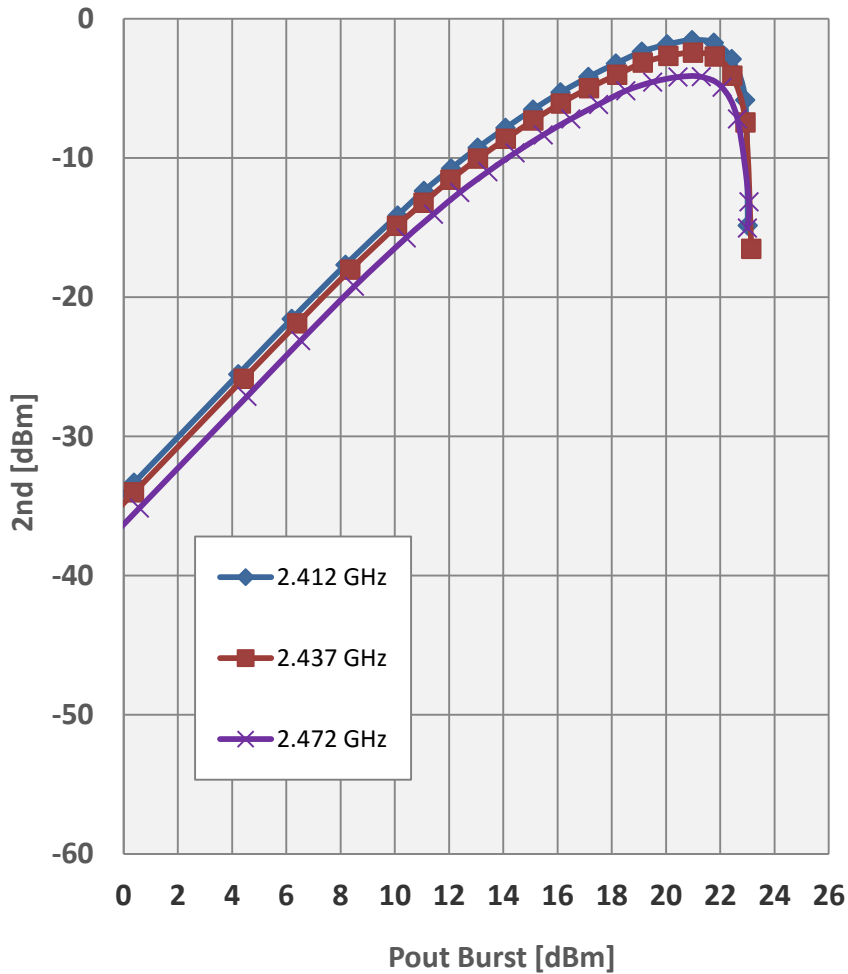

3rd Harmonic

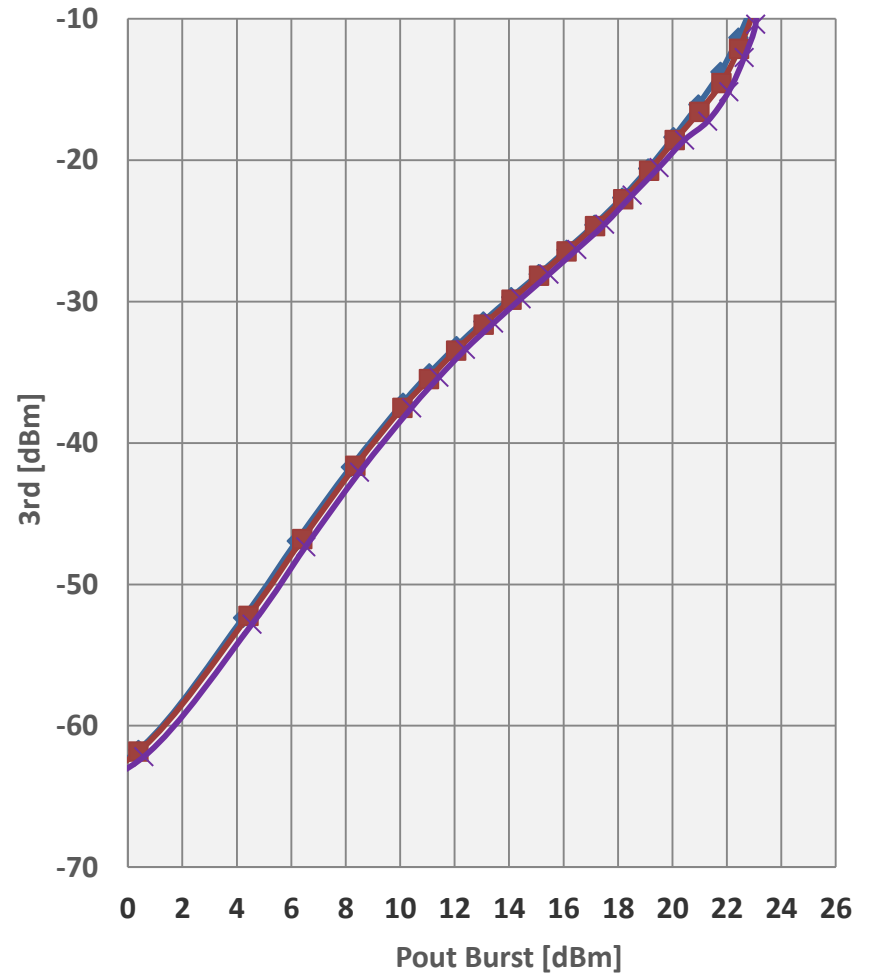

RFX8422S CW Power Detector over Frequency

VDD = 3.3V

Vdet VDD = 3.3V

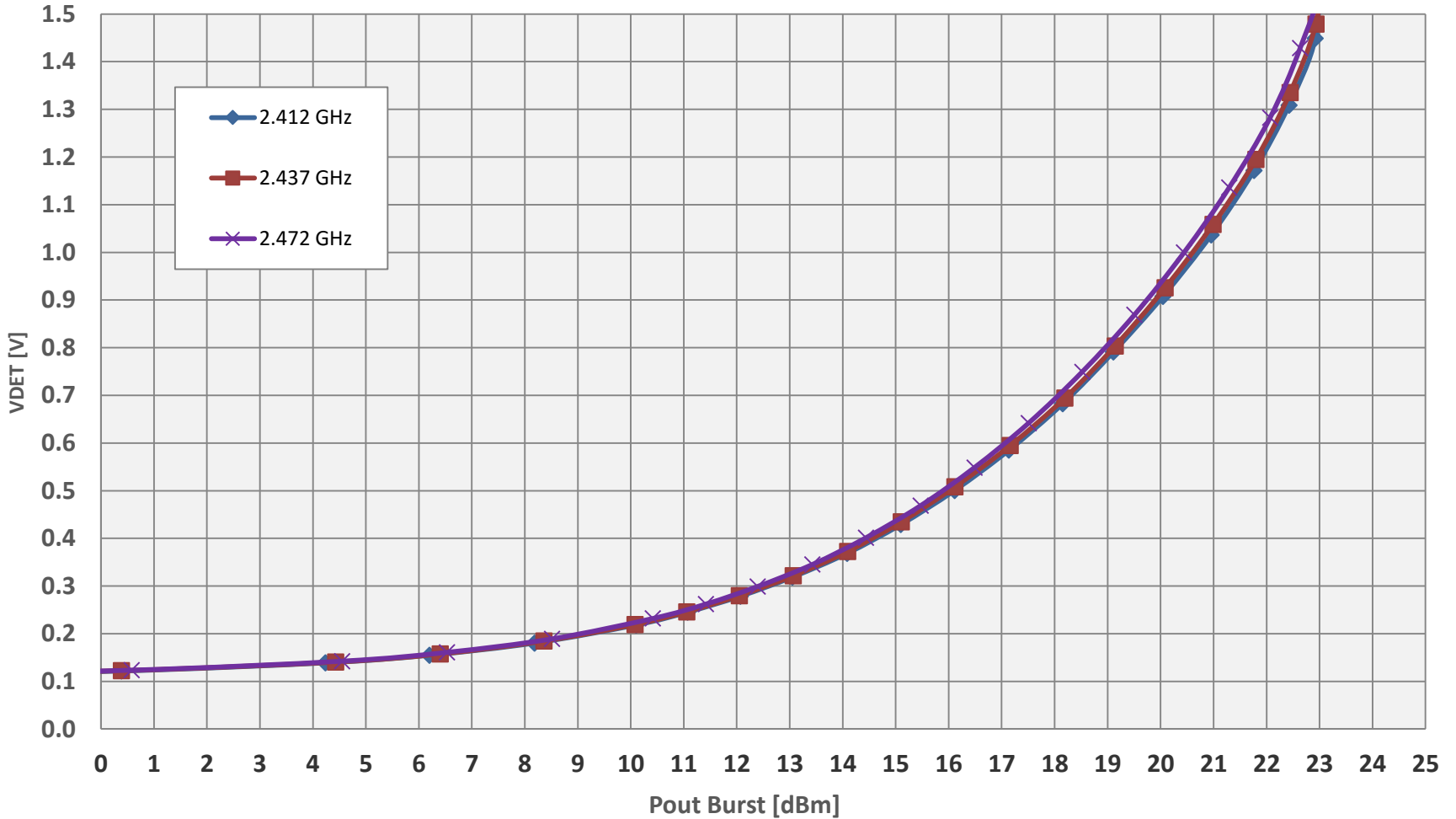

Detector voltage measured with 10kΩ load. Detector voltage will vary with different resistor load values.

RFX8422S LNA Gain and Noise Figure vs. Frequency

VDD = 3.3V

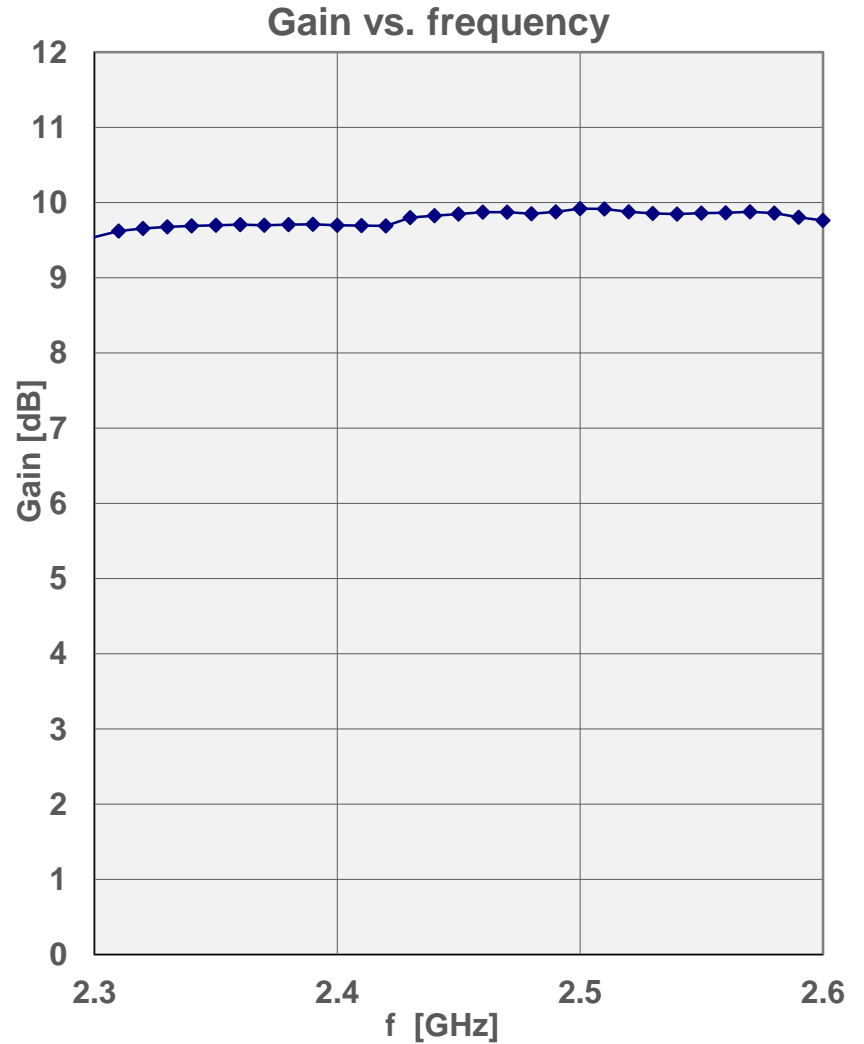
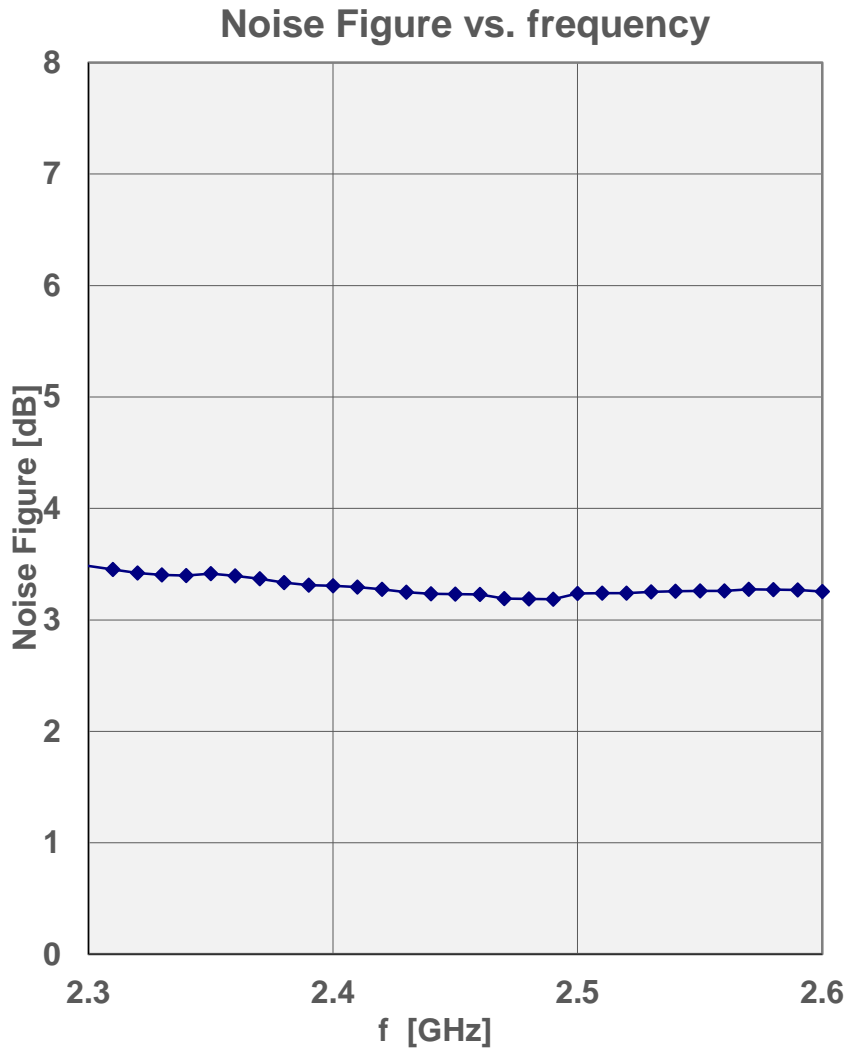

RXEN=High, LEN=High, TXEN=BTEN=Low, Iq= 11 mA

Mouser Electronics

Authorized Distributor

Click to View Pricing, Inventory, Delivery & Lifecycle Information:

[Skyworks:](#)

[RFX8422S-EVB](#)